

## GRAMOPHONES

22GF 110/02S/03S/04S/17S  
02X/03X/04X/17X  
02L/04L/15L



TGR 1471

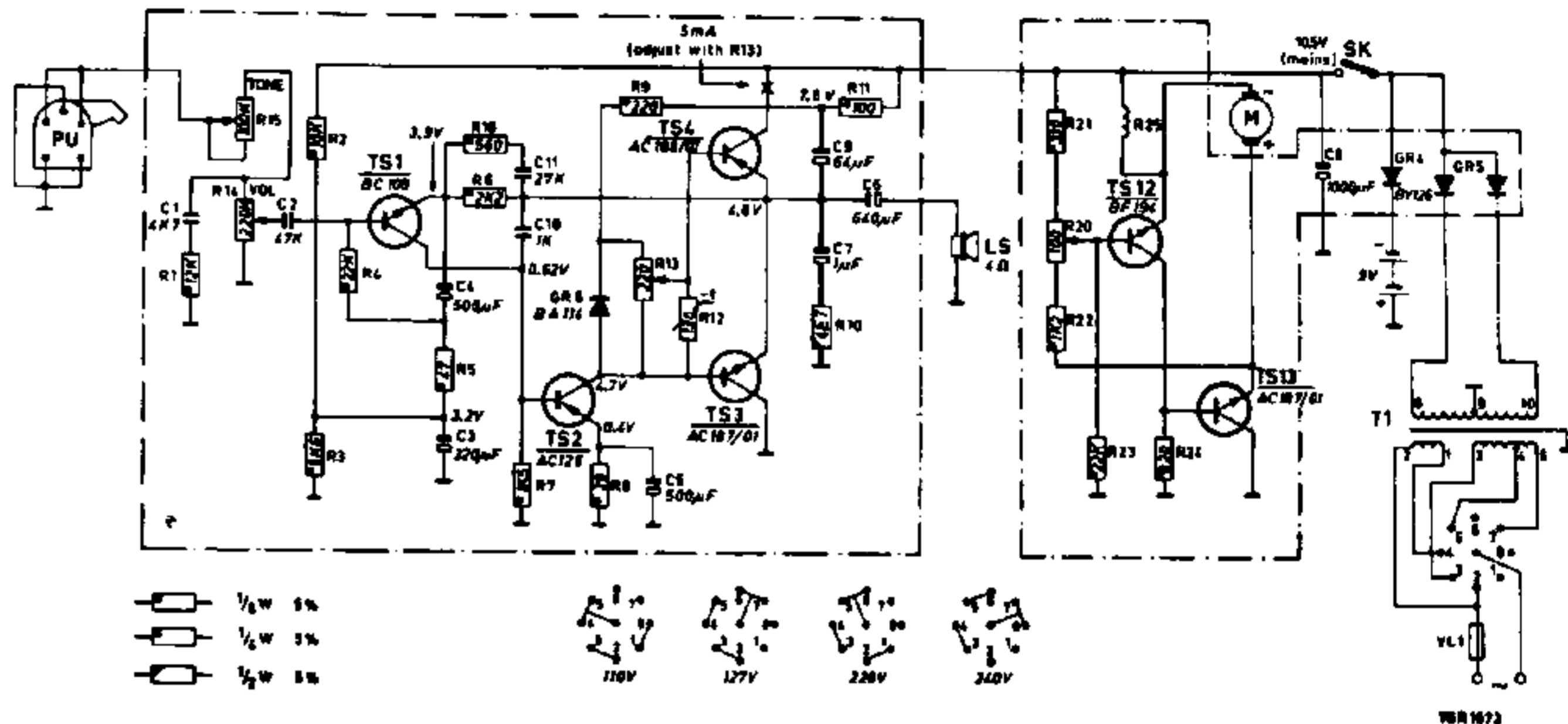
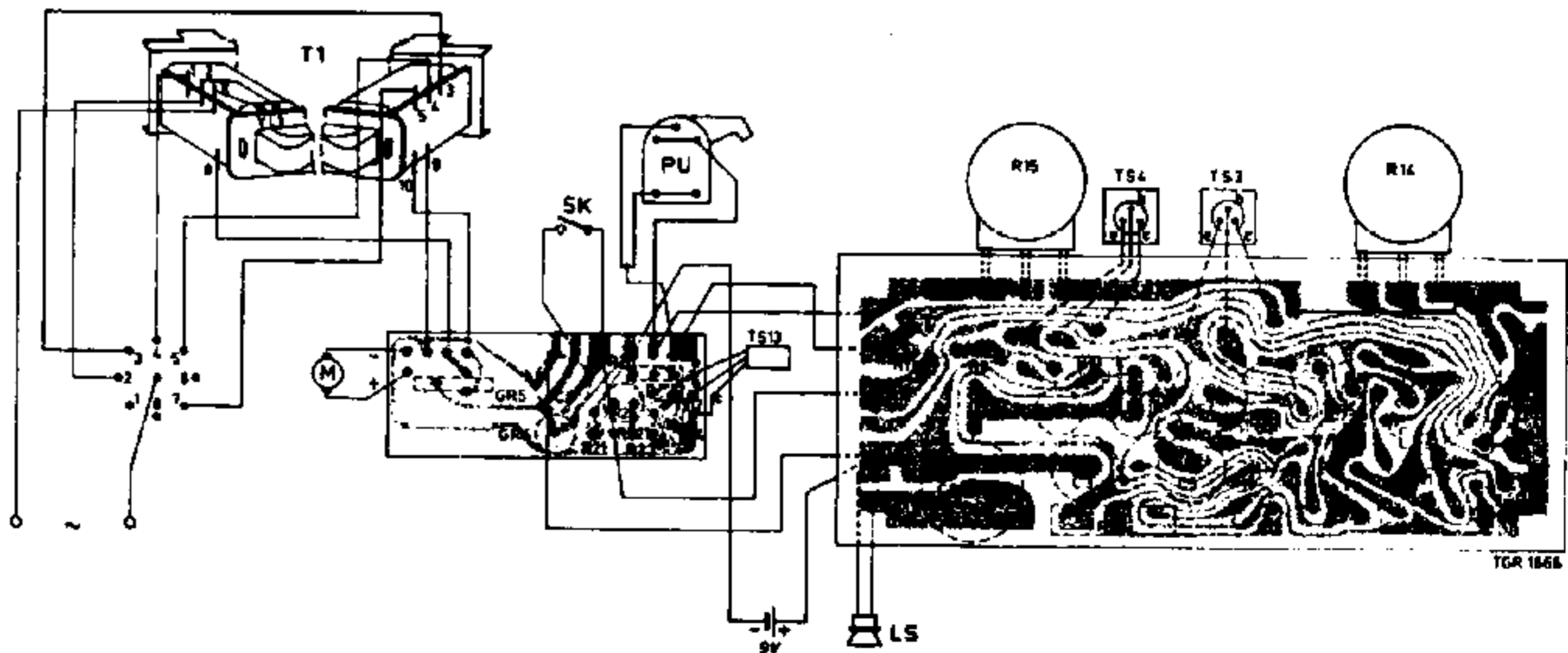

Fig. 1



TGR 1866



With this, the Service Notes of the 22GF110, Code numbers 4822 726 10136 and 4822 726 10219 are deleted.

The 22GF110 is a record-player with amplifier and loudspeaker built into a plastic case. For repairs and replacements of parts, see the Service Notes of the 22GC010, with the exception of the code numbers in the list of mechanical parts.

### Technical data

Mains voltages	: 110-127-220-240 V
Mains frequency	: 50 Hz
Battery voltage	: 9 V
Output power	: 1.6 W (d= 10 %)
Power consumption	: 5.5 W
Current consumption in case of battery supply	: max 325 mA
R. p. m. s.	: 33 1/3 - 45 - 78
Dimensions	: 405 x 218 x 77 mm
Loudspeaker impedance	: 4 Ω
P. U. heads	: GP 306 - GP 310 - GP 224 - GP 225





24-5-1968	22 GF 110	Bc 763
-----------	-----------	--------

**Information**

During the production of the 22 GF 110 three different supply transformers were applied:

1. The transformer drawn in Figs. 1 and 2 of the Service Notes.  
This transformer is no longer supplied.
2. The transformer, which is supplied under code number 4822 145 30069. This transformer replaces the transformer mentioned above and is identical to it with the exception of the connection points, which are positioned differently. For this, see Fig. 1 below.
3. The transformer drawn in Fig. 2 below. This is supplied under code number 4822 145 30057.

For this transformer a different voltage adapter is used with only one interconnection in the adapter knob.

Code number adapter knob: 4822 263 30076

Code number adapter plate: 4822 263 40024.

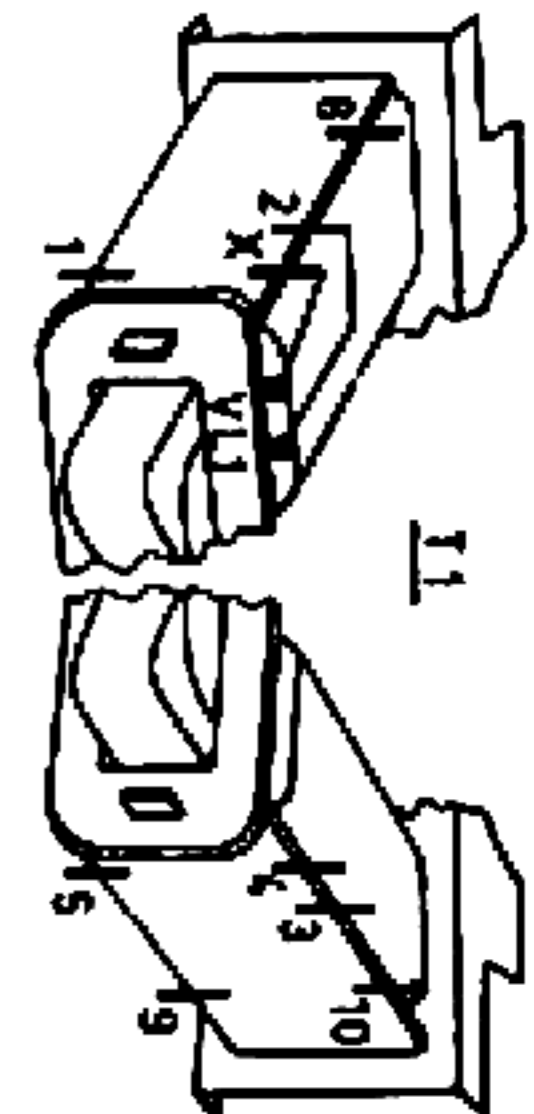
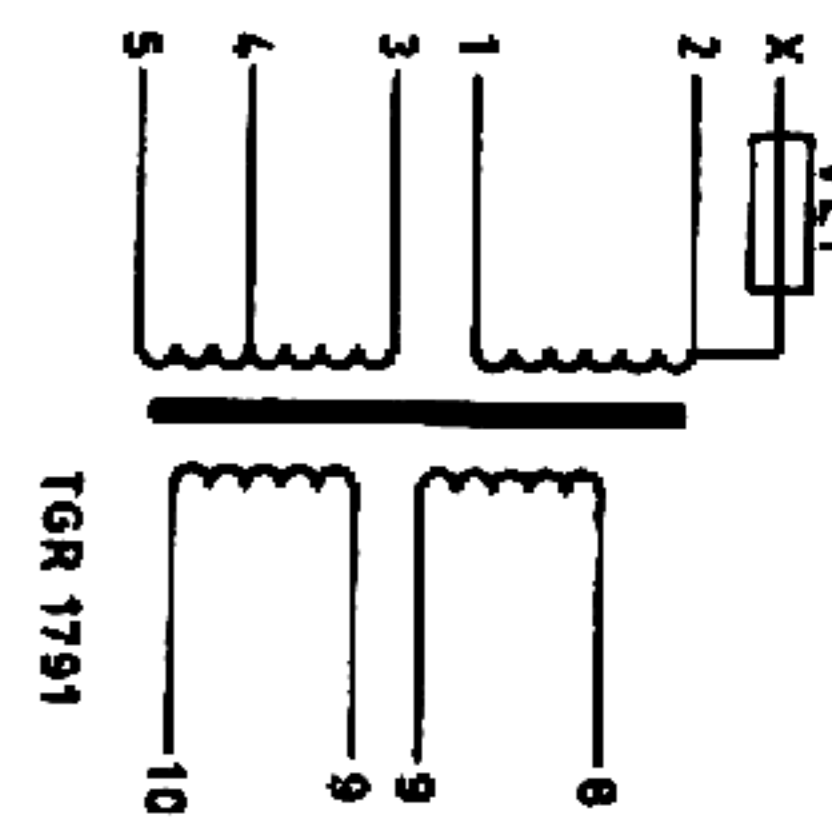
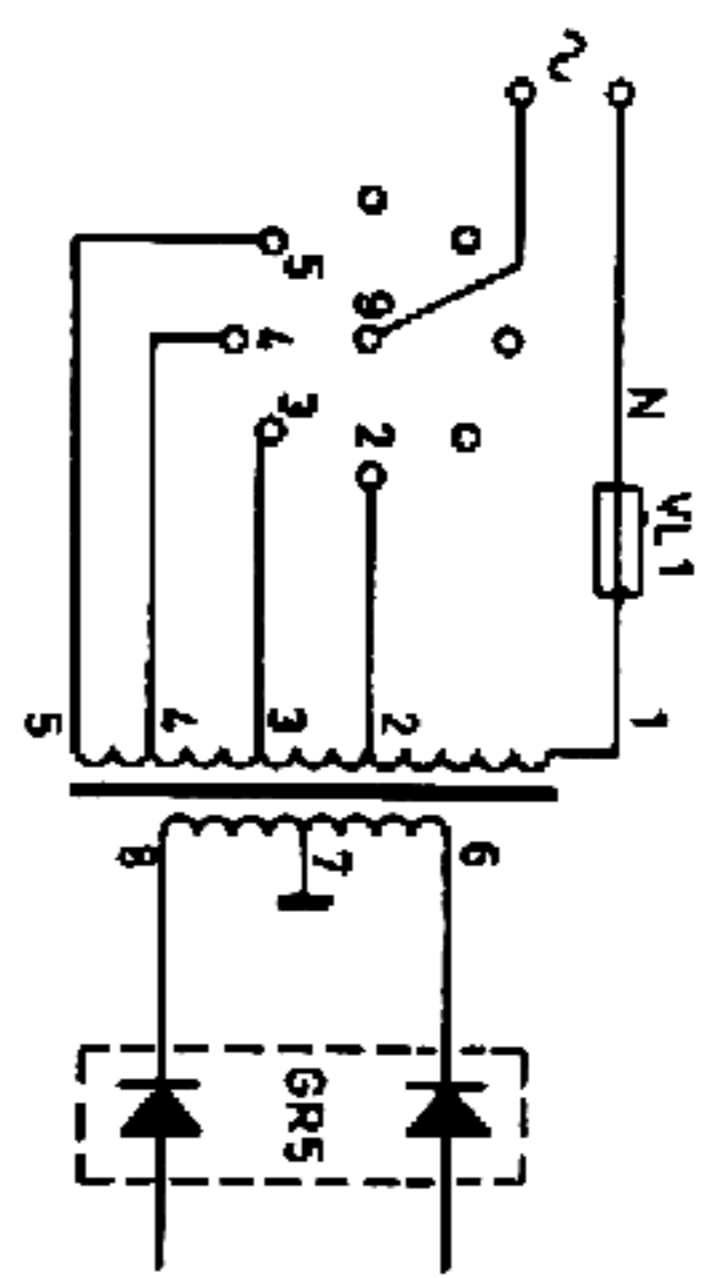
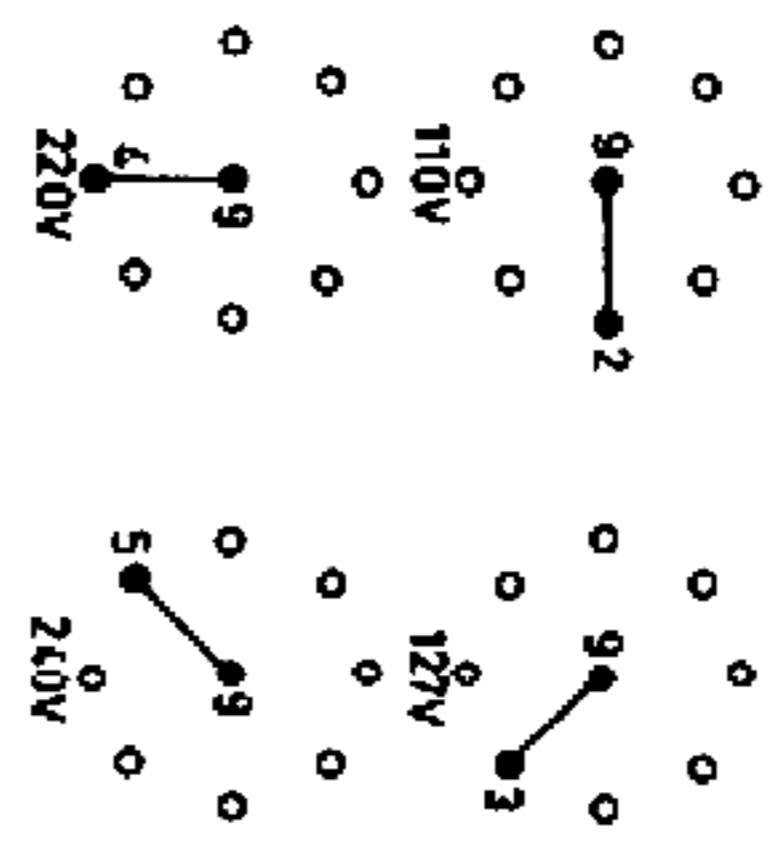

Fig. 1



TGR 1791

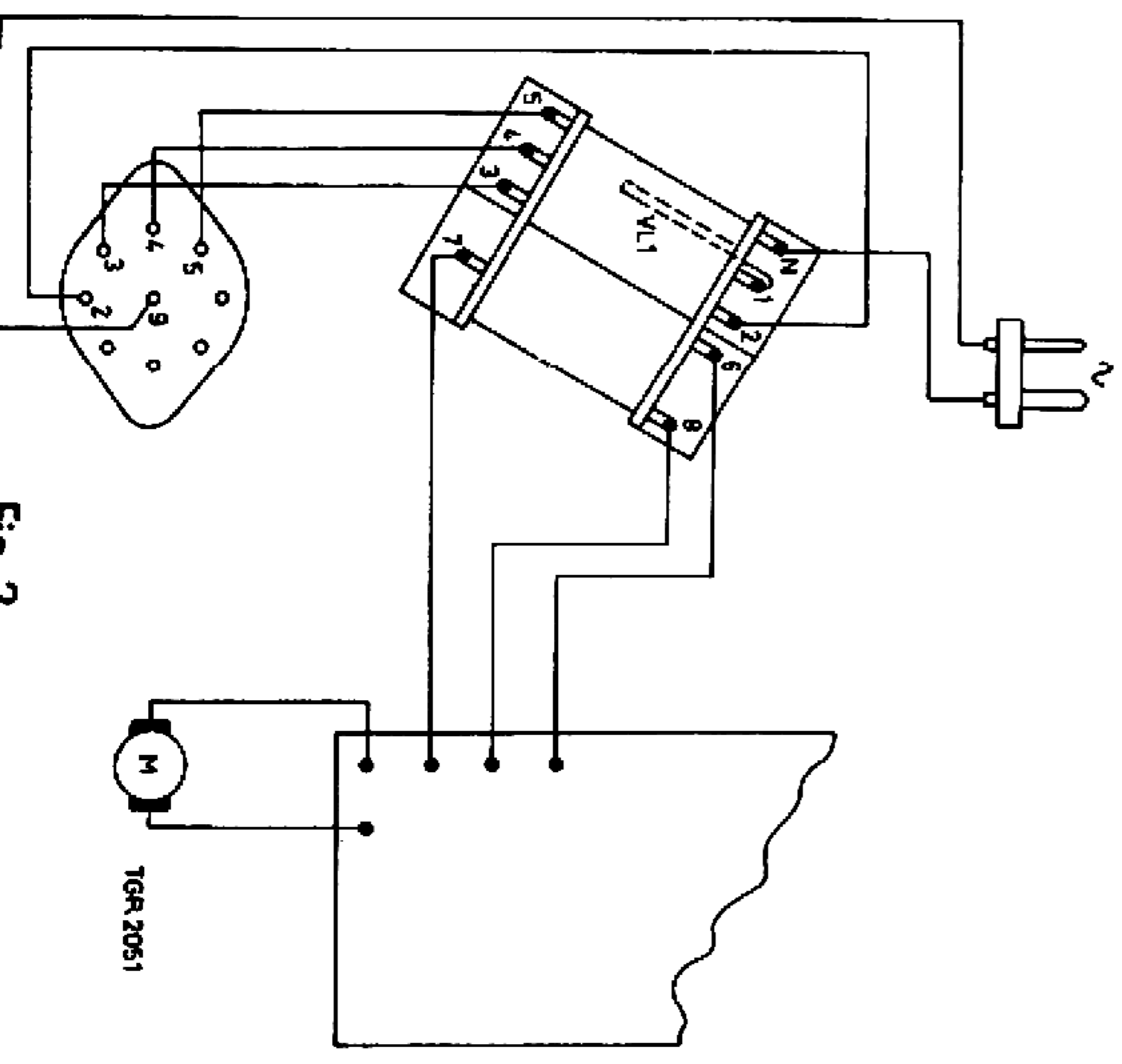

Fig. 2

TGR 2051